

UV-VIS Spectrophotometers

# UV-2600/2700



Experience the Precision Desired,  
in Any Situation



**UV-2600/2700**  
UV-VIS Spectrophotometer

### Single monochromator UV-2600

## Capable of a Measurement Wavelength up to 1400 nm

- Equipped with a single monochromator, providing low noise performance across a wide wavelength range
- Enables near-infrared measurements (up to 1400 nm)\*

\* When the optional ISR-2600Plus integrating sphere is used

### Double monochromator UV-2700

## Performance with a Minimum 8-Abs Photometric Range

- Equipped with an ultra-low stray light double monochromator, capable of 8-Abs measurements
- Uses the Shimadzu proprietary Lo-Ray-Ligh grade diffraction grating

## Even More Compact and User-Friendly

- A compact 450 mm width size, reducing the required installation space by 28 %\*
- Achieves 10 %\* energy savings compared to other Shimadzu systems
- Validation software is included as standard

\* In comparison to the conventional UV-2450/2550 models

## With a Wealth of Accessories, Accommodates Every Application

- Freely expandable to suit the measurement objective
- Existing system accessories can also be used
- Automated data processing



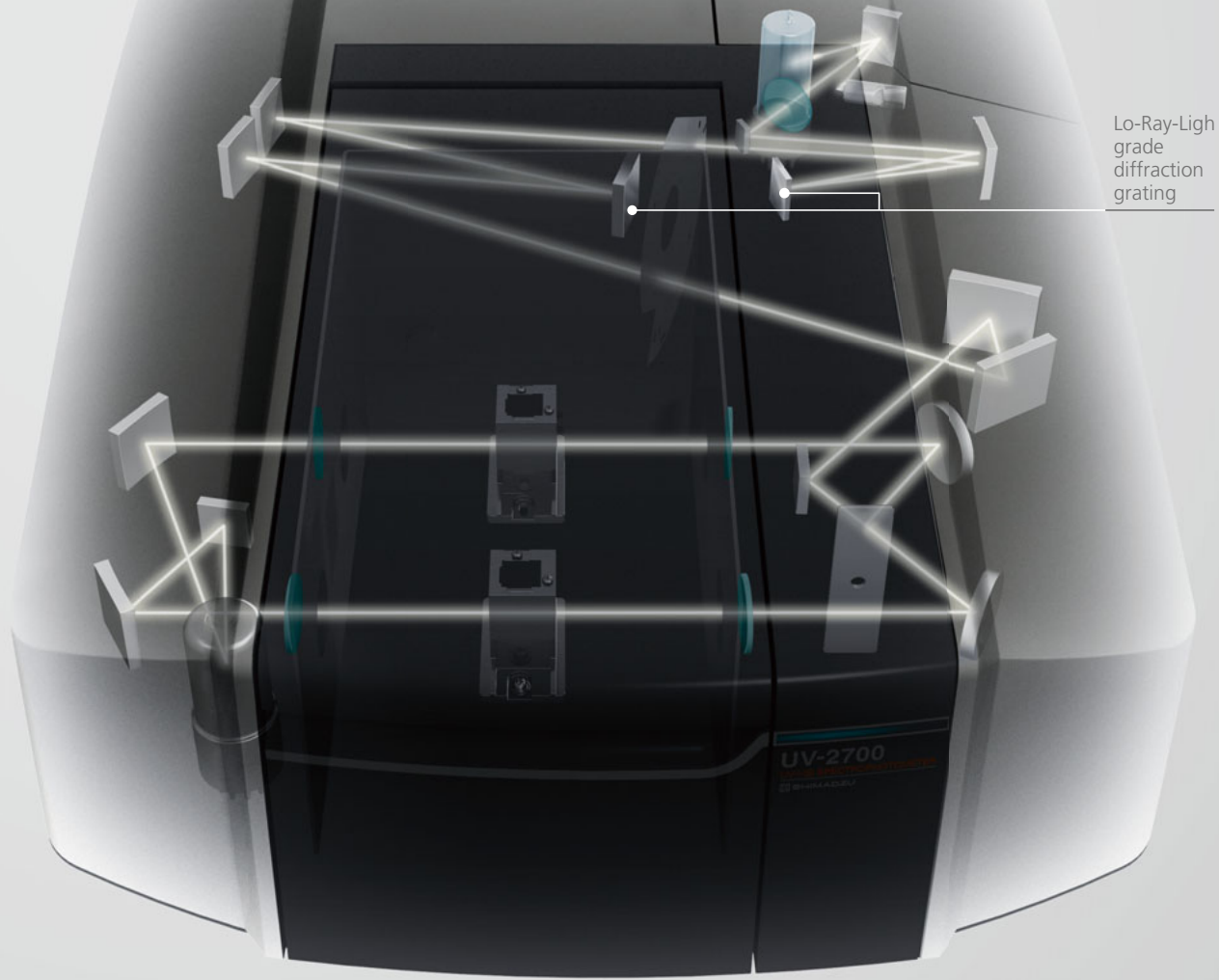

Lo-Ray-Light  
grade  
diffraction  
grating

## Achieves Ultra-Low Stray Light, Enabling 8-Abs Measurements

Conventional models provide 5-Abs coverage. Even high-end models have been limited to 6 Abs. In contrast, the UV-2700 achieves ultra-low stray light levels, expanding the range to 8 Abs, with a transmittance value of 0.000001 % (1 part in 100 million). This system achieves high-level absorbance measurements with incomparable precision. In addition to measuring even high-concentration samples as is, eliminating the need to dilute samples, the system can be applied to evaluating the transmission characteristics of polarization films. Wavelengths in the 400 nm to 650 nm range can be measured to 8 Abs.

### Absorbance Linearity

UV-2700

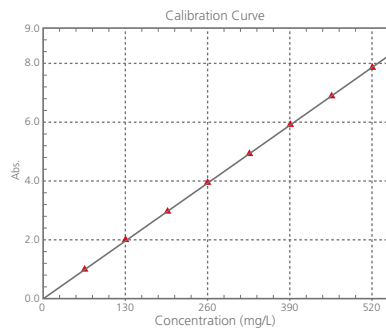

This shows the relationship between the absorbance and the concentration of an aqueous potassium permanganate solution. Good linearity is evident to 8 Abs.

### Spectral Comparison of Aqueous Potassium Permanganate Solutions

UV-2700

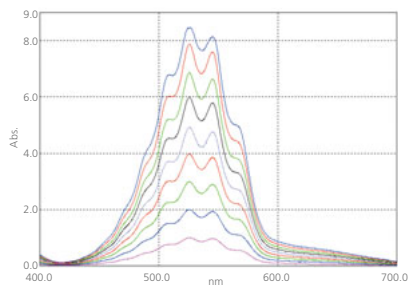

UV-2700

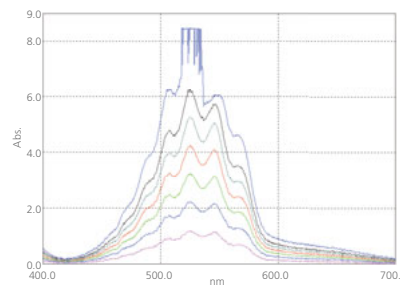

UV-2550 (Conventional Model)

This spectrum is measured from an aqueous KMnO4 (potassium permanganate) solution. Unlike conventional models, this system is capable of high-level absorbance measurements.

## Double monochromator UV-2700

# Performance with a Minimum 8-Abs Photometric Range

Equipped with a double monochromator that achieves ultra-low stray light levels, the UV-2700 is optimal for measuring low transmittance samples, such as polarization films used for LCD panels. The UV-2700 is capable of 8-Abs measurements, and can make accurate transmittance measurements to 1 part in 100 million, accommodating a variety of sample measurements.

### Sample Polarization Film Measurement

UV-2700

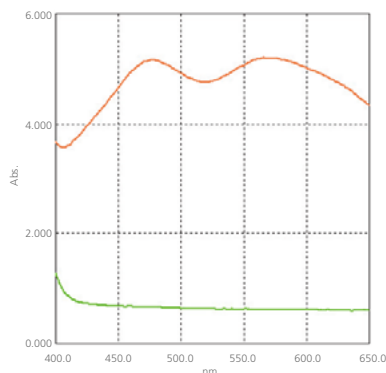

With the rotating film holder (photograph below), two film samples can be set on the same optical axis. In this example, the polarization film is rotated in the plane, and the transmittance is measured when the film transmits and blocks light.

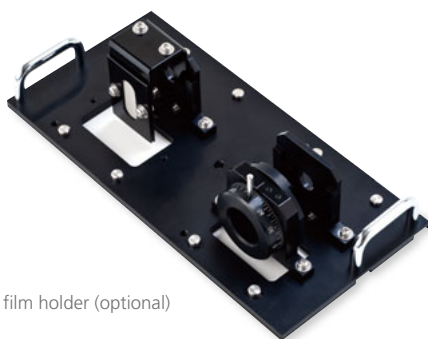

Rotating film holder (optional)

### Equipped with Shimadzu's Proprietary Lo-Ray-Ligh Grade Diffraction Grating

Shimadzu's proprietary Lo-Ray-Ligh grade diffraction grating enables the high precision of the UV-2700. In the diffraction grating production process, new proprietary manufacturing methods have been developed for Shimadzu's holographic technology. By optimizing the etching process, we have successfully manufactured extremely low stray light diffraction gratings while maintaining high efficiency. With this a newly designed optical system equipped with a double Lo-Ray-Ligh monochromator, the UV-2700 achieves unparalleled ultra-low stray light levels.



**UV-2600/2700**  
UV-VIS Spectrophotometer



## Single monochromator UV-2600

# Capable of a Measurement Wavelength up to 1400 nm

A key feature of the UV-2600 single monochromator type is its measurement wavelength range. By using the optional ISR-2600Plus Integrating Sphere attachment, the measurement wavelength range can be extended from 220 nm to 1400 nm, significantly expanding its applications.

## Integrating Sphere Enables Measurements to 1400 nm

The UV-2600 is also equipped with Shimadzu's proprietary Lo-Ray-Ligh grade diffraction grating, which achieves high efficiency and low stray light levels. By installing the ISR-2600Plus two-detector integrating sphere, the 300 nm to 1100 nm wavelength range of conventional models can be extended to 1400 nm. In addition, the UV-2600 achieves a significant noise reduction, and can accommodate measurements of solar cell anti-reflective films and polycrystalline silicon wafers.

### Wider Measurement Wavelength Range UV-2600

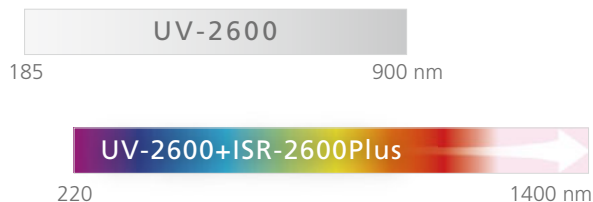

### Comparison of Data Noise Levels UV-2600

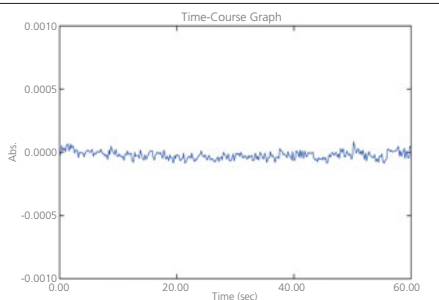

500 nm, 2 nm slit width, 0.2 sec sampling pitch, 0.2 sec integration time  
UV-2600

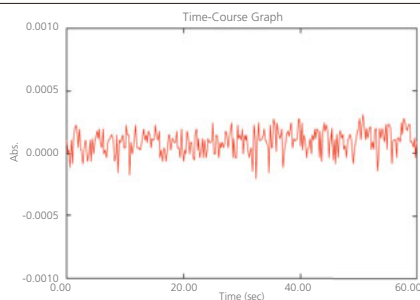

500 nm, 2 nm slit width, 0.2 sec sampling pitch  
UV-2450 (Conventional Model)

Noise levels are significantly reduced in comparison to the conventional UV-2450 model.





### Transmission Measurements of Polycrystalline Silicon Using the ISR-2600Plus

UV-2600

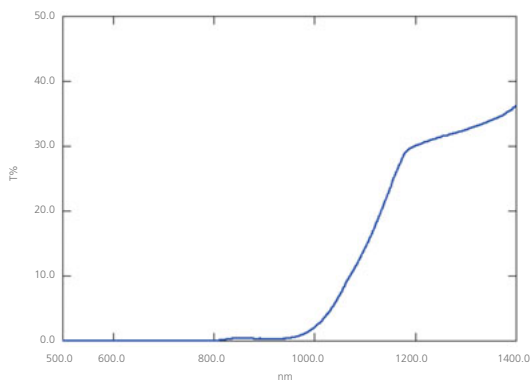

This is a transmission measurement of polycrystalline silicon. Since the system is capable of measurements to 1400 nm, the transmission characteristics of the band gap region (near 1000 nm) are clearly evident.

### Relative Diffuse Reflection Measurements of an Anti-Reflective Film Using the ISR-2600Plus

UV-2600

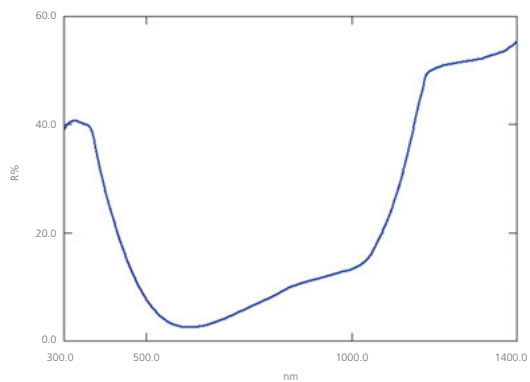

This is a reflection measurement of an anti-reflective film. With relative reflection measurements, the system can measure from the ultraviolet region up to the near-infrared region, so the suppressed reflectance in the visible region is clearly evident.

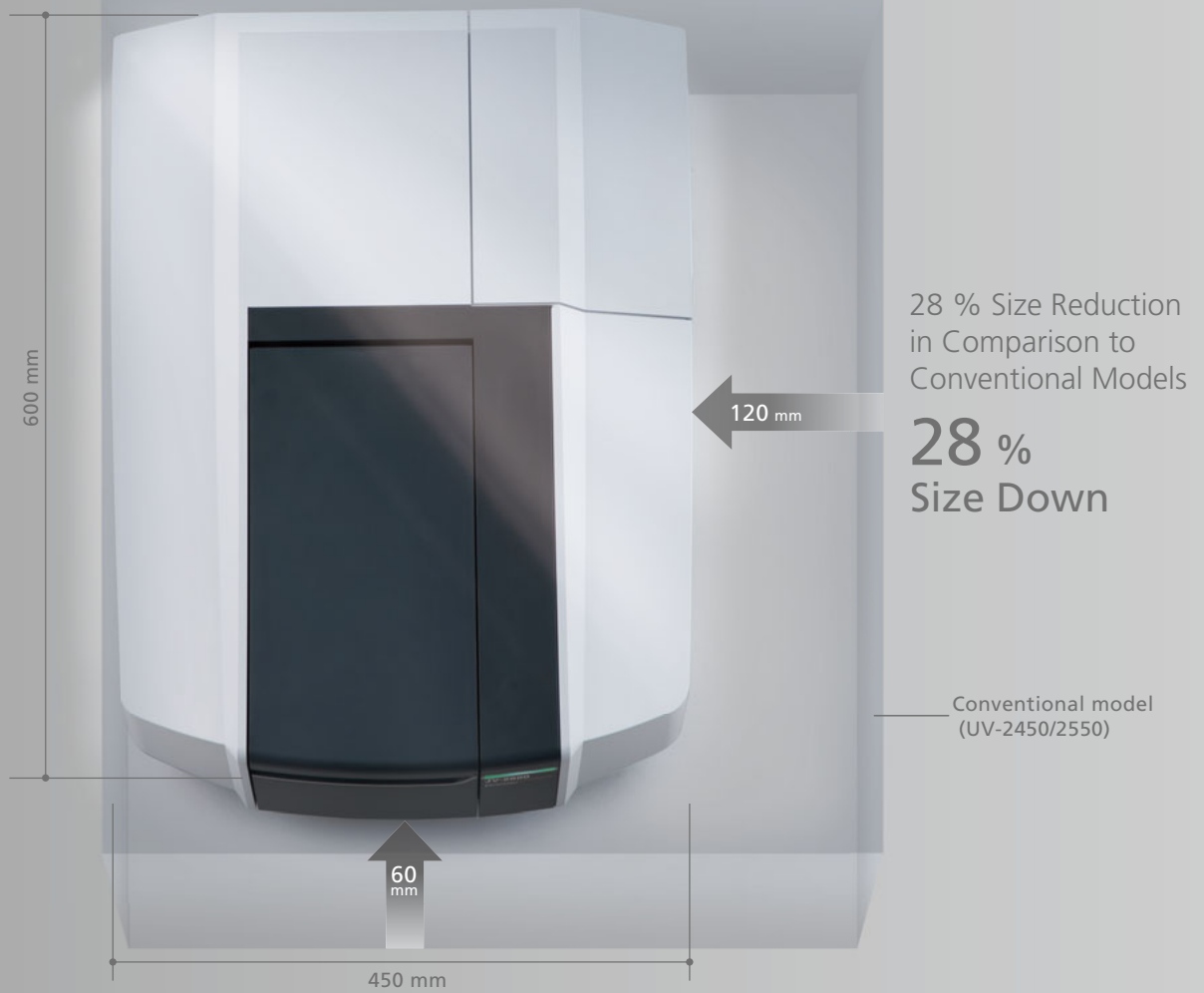

## Compact 450 mm Width Size

With the space-saving UV-2600/2700 models, the sample compartment size remains the same despite a 20 % reduction in installation width. A variety of film and other measurements can be performed effortlessly, without sacrificing user-friendliness. In addition, the cooling fan is built into the side of the unit, so that it can be pushed back all the way to the wall. By placing in contact with the wall, limited bench space can be more effectively utilized.



## Achieves 10 % Power Savings in Comparison to Conventional Models

The 190 VA power consumption of conventional models has been reduced to 170 VA. A 10 % energy saving makes the system more environmentally friendly.

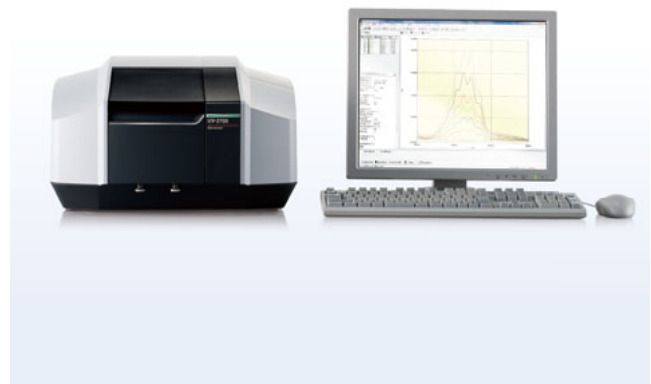



# Single monochromator UV-2600 Double monochromator UV-2700

## Even More Compact and User-Friendly

To respond to feedback that conventional models are too large, we have challenged ourselves to maximize space savings. The installation space required for this system has been reduced by about 28 %, thanks to a brand new compact design. In addition, validation software is provided as standard, so equipment inspections are easily performed, further enhancing user-friendliness.

### 28 % Size Reduction in Comparison to Conventional Models

## Validation Software Provided as Standard to Support GLP/GMP

Validation software assists with equipment performance checks and the logging of such checks. Validation software, which has been available as an option, is included as standard with the UV-2600/2700, thereby achieving easier instrument check. Equipment performance can be easily checked in daily inspections and when data accuracy becomes a concern.

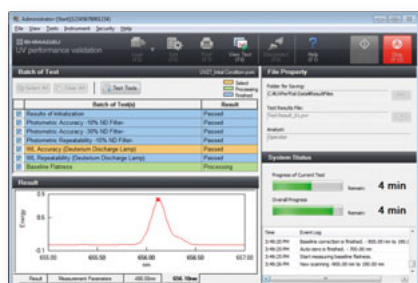
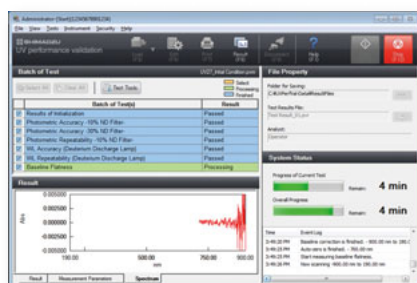

- Inspection results can not only be printed, but also saved to a file, with results called up later for confirmation.
- Inspection conditions for each periodic and routine inspection can be saved as a file, and then called up for use.
- Equipment performance can be checked according to the performance indication standards specified in JIS K0115 "General rules for molecular absorptiometric analysis," as well as to Japanese Pharmacopoeia general test methods or various EP and USP inspection methods. (Inspection tools and reagents must be prepared separately.)
- Mercury bright line wavelength checks can be performed using the optional low-pressure mercury lamp unit.

Single monochromator UV-2600  
Double monochromator UV-2700

## With a Wealth of Accessories, Accommodates Any Application

The functionality of the UV-2700/2600 can be freely expanded to suit the measurement objective. By accommodating a wealth of accessories, the system can address any user's applications and a variety of situations. Thanks to intuitive operations, anyone can easily obtain the data required.

Accessories have been prepared to accommodate a variety of applications such as temperature-controlled, micro-volume, and multisample measurements.

Thermoelectrically  
Temperature-Controlled Cell Holder UV-2600 / 2700

This enables measurements while adjusting the temperature of the sample (solution).



Sipper Unit UV-2600 / 2700

The sample (solution) is suctioned up for measurement, and then discharged.

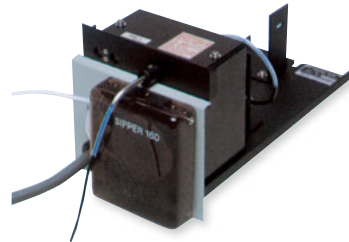

Supermicro Cell Holder UV-2600 / 2700

This is for measurement of trace quantity samples (solutions).

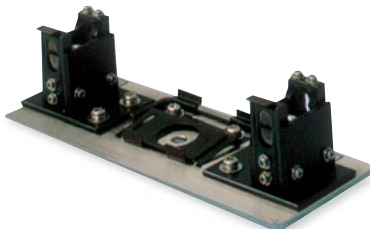

Multi-Cell UV-2600 / 2700

Samples (solutions) are placed in the six cells, for sequential measurement.

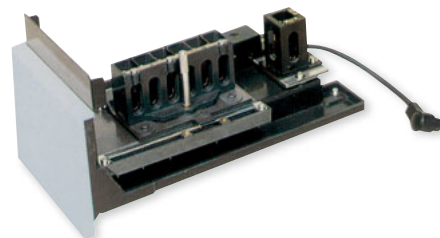

# Analysis Correspondence Chart

UV-2600 | UV-2700

Electricity, Electronics, and Optics		
High-level absorbance measurements for polarization films	F	E
Absolute reflectance measurements for anti-reflective films	E	F
Transmittance measurements for functional films	E	E
Transmittance measurements for solar cell cover glass	E	F
Band gap measurements and diffuse reflectance measurements for semiconductor materials	E	F
Absolute reflectance measurements for highly reflective mirrors	E	F
Chemicals		
Transmittance and reflectance measurements for various types of films	E	F
Thin film thickness measurements	E	E
Plastic transmittance measurements, reflectance measurements, and color measurements	E	F
Medicines, Cosmetics, and the Life Sciences		
Raw material confirmation tests	E	E
Enzyme reaction measurements	E	E
Protein and nucleic acid quantitation	F	E
Cosmetic color measurements and ultraviolet screening measurements	E	F

UV-2600 | UV-2700

Environment		
Hexavalent chromium quantitation	F	E
Quantitation of total phosphorus and total nitrogen in river water, lakes, and marshes	F	E
Turbidity measurements	E	F
Quantitation of iron, copper, arsenic, ammonia, and other substances in water	F	E
Construction		
Transmittance measurements for window glass and window glass films	E	F
Reflectance measurements for paints and building materials	E	F
Textiles		
Textile transmittance and reflectance measurements, and ultraviolet screening measurements	E	F
Textile color measurements	E	F
Foods		
Quantitation of vitamins, food additives, and minerals	F	E
Quantitation of phenols leached from containers and packing agents	F	E

E: excellent F: fair

## Automated Data Processing

After spectra are measured, the software can perform data processing automatically in conjunction with the raw data, and can then display the results.

Peak detection, data operations (such as smoothing, differentiation, and basic arithmetical operations), point picking, and area calculations can be selected for automatic data processing.

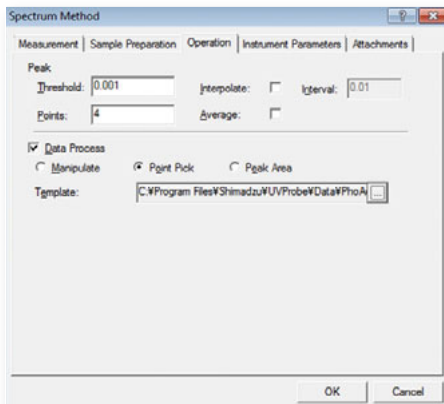

Measurements together with the data processing to execute can be configured on the [Operation] tab in the [Spectrum Method] window.

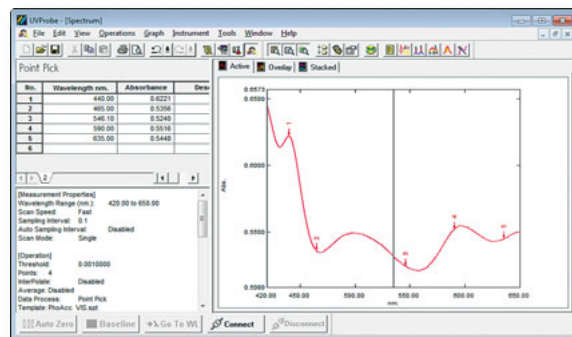

This example shows automated point picking after measurement. Data values for any wavelength can be shown onscreen.

# A Wealth of Applications

## Electricity, Electronics, and Optics

## Band Gap Measurements for Compound Semiconductors



The diffuse reflection spectra for two types of compound semiconductors (red line:  $\text{CuIn}_{0.5}\text{Ga}_{0.5}\text{Se}_2$ , blue line:  $\text{CuInSe}_2$ ) used as solar cell materials have been measured using the ISR-2600Plus integrating sphere. It is evident that the absorption edge (position where the reflectance drops) differs depending on the sample. This difference signifies a difference in the band gap\* for these samples. (The samples were provided by Wada Laboratory, Faculty of Science and Technology, Ryukoku University.)

The band gaps for the samples were calculated utilizing the Tauc method. The results obtained were 1.27 eV for  $\text{CuIn}_{0.5}\text{Ga}_{0.5}\text{Se}_2$  (red line) and 0.99 eV for  $\text{CuInSe}_2$  (blue line).

\* The term band gap refers to the energy difference between the top of the valence band, which is full of electrons, and the bottom of the conduction band, which does not contain electrons.

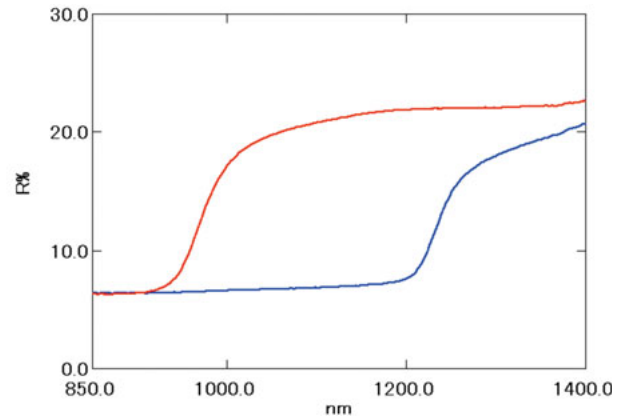

## Chemicals

## Thickness Measurements of Cling Films



Undulating interference waveforms sometimes occur if light is passed through a film. The film thickness of a sample can be determined by using these interference waveforms. The figure shows transmittance data for a cling film. A clear interference waveform is produced. Utilizing optional film thickness measurement software, the film thickness is calculated as 10.4  $\mu\text{m}$ .

(Caution) The sample's refractive index must be entered for the film thickness calculation.

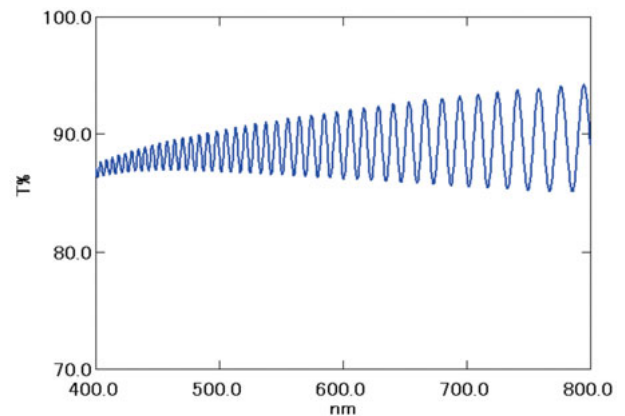

## Life Sciences

## DNA and Protein Measurements



The red and blue lines are the absorption spectra for dsDNA and BSA (bovine serum albumin), respectively.

The concentration values are 45  $\text{ng}/\mu\text{L}$  for dsDNA and 2.2  $\text{mg}/\text{mL}$  for BSA.

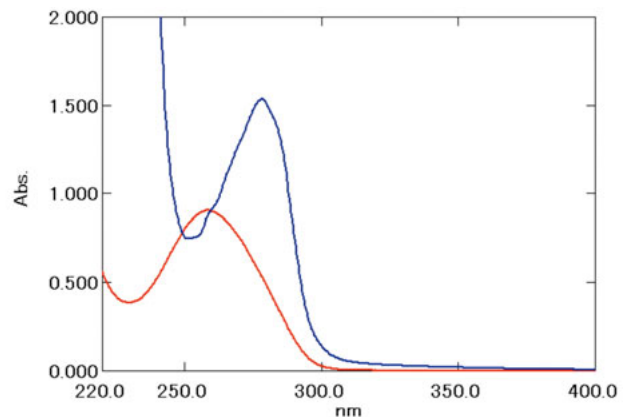

## Environment Hexavalent Chromium Measurements



An aqueous solution of hexavalent chromium was colored with a diphenylcarbazide reagent, and the absorption spectrum was then checked. It is evident that the maximum absorption peak is at 542 nm. By using a calibration curve, the concentration of this sample was found to be 0.843 mg/L.

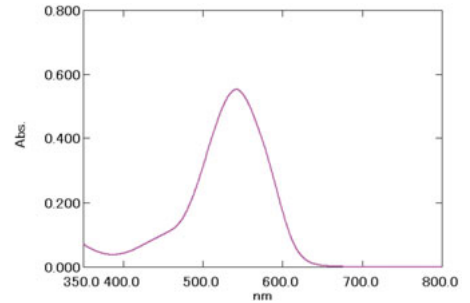

## Construction Window Glass Transmission Measurements



Two types of window glass were measured utilizing the ISR-2600Plus integrating sphere. The sample shown by the red line is highly transparent to near-infrared light at 800 nm or more. The sample shown by the blue line, however, is apparently not very transparent to near-infrared light.

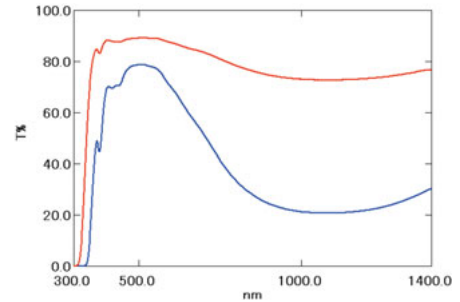

## Textiles Diffuse Reflection Measurements of Various Cloths



The diffuse reflection spectra for various textiles were measured in the visible range utilizing the ISR-2600Plus integrating sphere. The blue line indicates a blue cloth, and the red line a red cloth. The blue cloth appears blue because it primarily reflects short-wavelength blue light. The red cloth appears red because it primarily reflects long-wavelength red light.

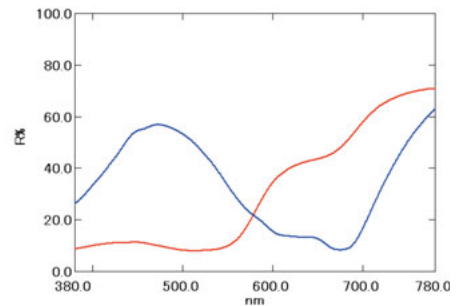

## Foods Vitamin Measurements



This shows the absorption spectra for riboflavin (vitamin B<sub>2</sub>). The sample concentrations are, in order from the highest absorbance, 0.08, 0.04, 0.02, and 0.01 mg/mL.

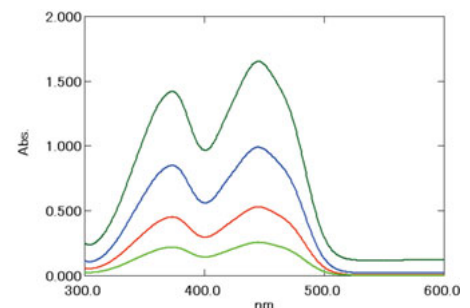

# UVProbe Software

## All-In-One Software

UVProbe is an all-in-one software package equipped with the following four functions:

- Spectrum module
- Photometric module (quantitation)
- Kinetics module (time-course measurement)
- Report generator

Each can be easily operated from its own special screen. In addition to a wealth of data processing functions, including peak detection and area calculations, the software is equipped with security functions to configure operational authority user by user, as well as data audit trail and equipment audit trail functionality.

### Spectrum Module

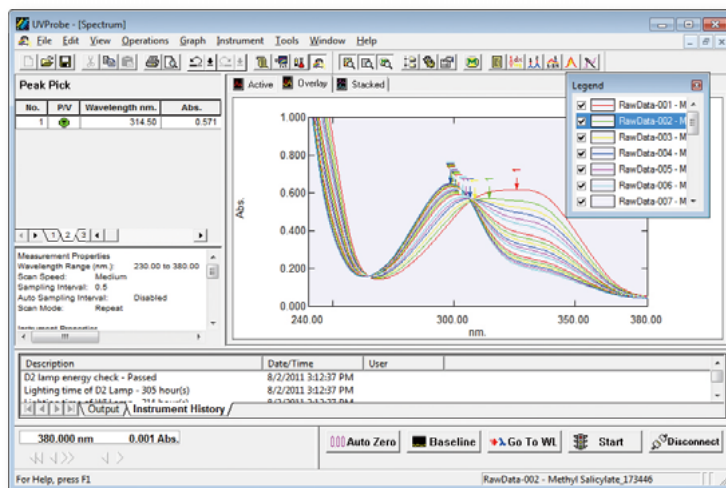

### Photometric Module

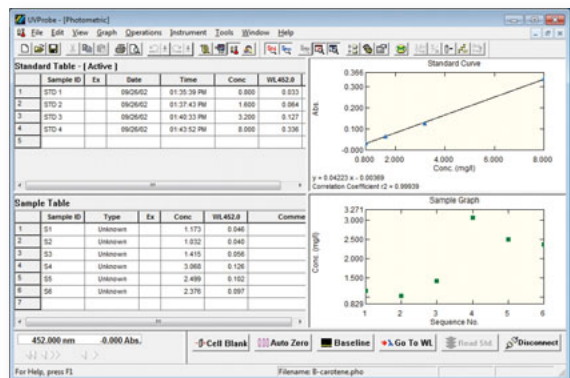

### Kinetics Module

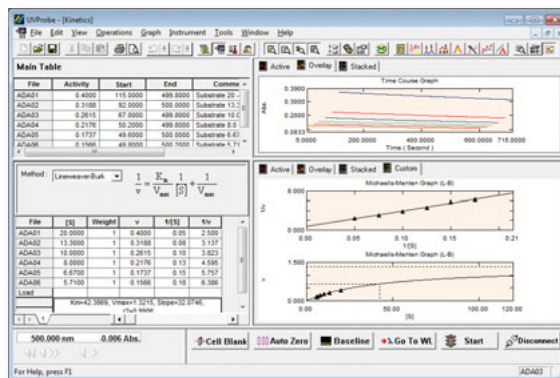

### Report Generator

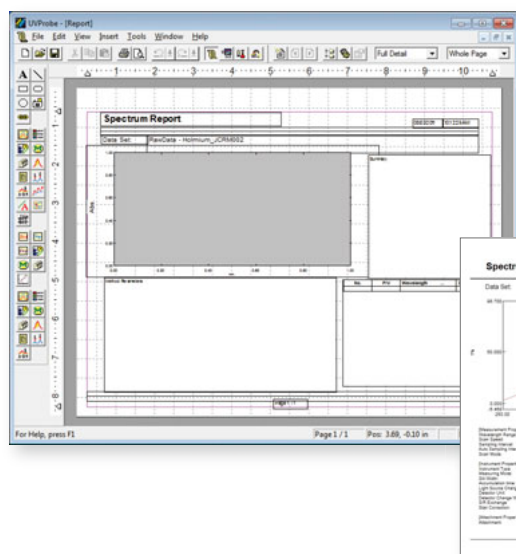

The report generator provides the freedom to arrange graphs, tables, etc. to suit users' needs. The thickness and color of graph lines, as well as font size, can now be specified. Pasting labels on graphs and editing text is as easy as can be, allowing the user to effectively print comments along with the analysis results.



## A Variety of Data Processing and Calculation Functions

- Data processing operations, such as peak detection and area calculation, and data conversion operations, such as differentiation and interpolation, can be applied to spectra and time-course data.
- With the kinetics module, the Michaelis constant ( $K_m$ ) or the maximum response speed ( $V_{max}$ ) can be calculated and plotted.

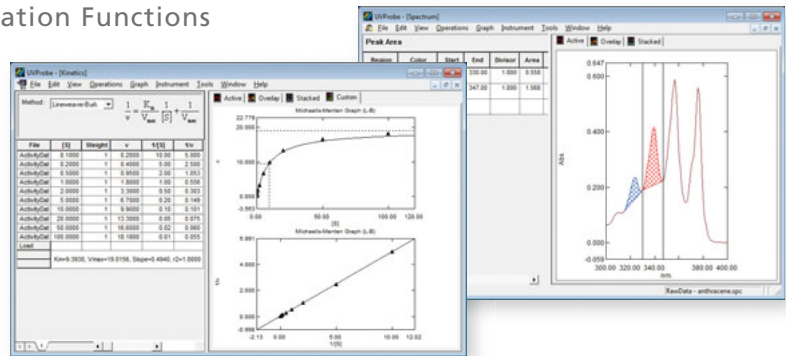

## Calculation Expressions and QA/QC Functions

- With the photometric module, calculation expressions can be defined for measurement results.
- Judgment expressions can be created for photometric values and calculation results.

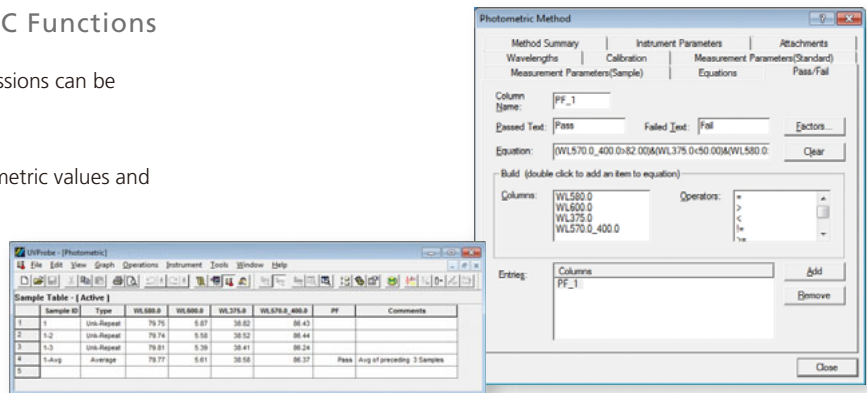

## GLP/GMP Support

- Security Functions**  
The use of functions can be restricted according to the user level.
- Audit Trail Function**  
Details of processes (e.g., baseline correction) that affect measurement data are tracked in the instrument's history.
- Data History Function**  
If a change is made to measurement data, a history of this is added to the data.

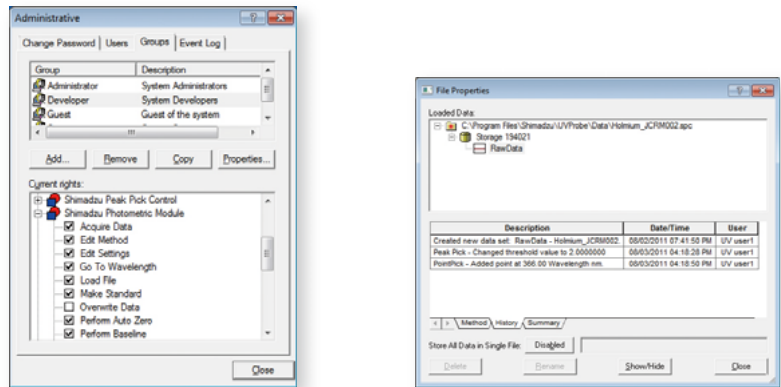

## Support for DNA/RNA/Protein Quantitation Methods as Standard

The table on the right shows protein/DNA quantitation methods included as standard with UVProbe. In addition to Lowry, BCA, Bradford, Biuret and other typical protein quantitation methods, the software supports a variety of DNA quantitation methods. A significant feature of UVProbe is that it provides the user with the opportunity to create different quantitation methods for samples other than protein/DNA.

UV Direct Measurement (280 nm)	Biuret method
DNA (double-stranded)	Lowry method
DNA (single-stranded)	Bradford method
DNA260, 230 with background correction	260/280 ratio with background correction
DNA260, 280 with background correction	260/280 ratio with no background correction
BCA Method	RNA quantitation method

Sample ID	WL260.0	WL230.0	WL280.0	corr260	corr230	DNA_equl	Protein	
1	a	1.354	1.130	0.050	1.304	1.080	60.268	90.797
2	b	0.674	0.558	0.050	0.624	0.508	26.871	46.666
3	c	0.360	0.287	0.032	0.320	0.255	15.217	21.803
4	d	0.553	0.456	0.039	0.514	0.417	23.786	37.550

# Optional Software

## UVProbe Agent Software

(P/N 206-21550-92)

The UVProbe Agent, which was developed for Shimadzu UV-VIS spectrophotometers, is used to automatically transfer and store the data acquired, or the results of performing data processing with the UVProbe software, to a general-purpose database, and to perform operations related to high-security data management and electronic signatures. This makes it possible for UVProbe to attain compliance with FDA 21 CFR Part 11. The UVProbe Agent is network-compatible; therefore, by installing other Agent software for corresponding analytical instruments, such as HPLC or FTIR spectrophotometers, data from all analytical instruments can be integrally managed at a server PC and browsed at client PCs.

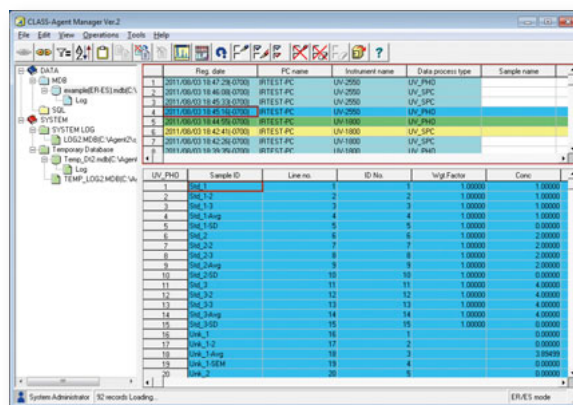

### Access Control and User Management

As with UVProbe, user access to the program is centrally managed by a user-authentication server without depending on the OS, enabling a level of access control that complies with FDA 21 CFR Part 11. It is also possible to restrict the functions that can be executed by authenticated users on an individual basis, eliminating the possibility of unauthorized users making erroneous changes to settings.

### Security and Audit Trails

All saved electronic records are stored and managed in a database, ensuring the original data is not lost when records are changed. Also, the contents of system usage records and records of changes made to data registered in the database are recorded together with the date and the name of the person concerned.

### Data Integrity and Electronic Signatures

Data is automatically stored in the database and is not deleted. This data can be easily restored, allowing it to be displayed or reanalyzed as necessary. Also, electronic signatures can be applied to electronically recorded data; this data is linked to analytical data, and the name of the signer, the date of the signature, and the reason for the signature are saved.

### Applicable OS: Windows 7 Professional

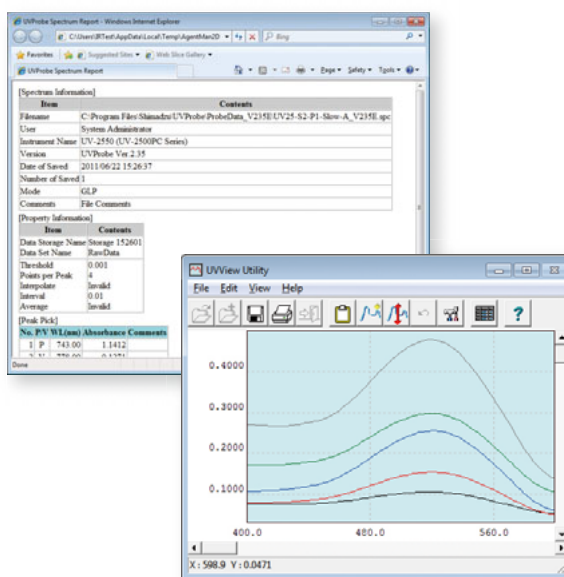

(Note) UVProbe software Ver. 2.00 or later is required.

## Tm Analysis Software

(P/N 206-57476-91)

This software works with the S-1700 and accumulates temperature-versus-absorbance curve data at the PC to analyze the Tm (melting temperature) of nucleic acids such as DNA and RNA.

### Applicable OS: Windows 7 Professional

(Note)

An RS-232C cable (P/N 200-86408) is needed to connect the PC to the S-1700.

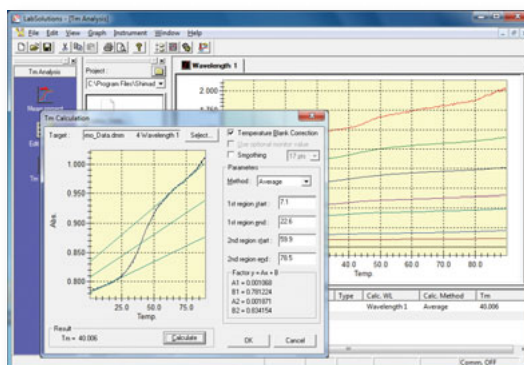

# Color Measurement Software

(P/N 206-67449)

This software calculates color values of the measurement sample from the spectrum measured.

## ■ Calculable Items

Tristimulus value (XYZ), chromaticity coordinates (xy), Hunter color coordinate system/color difference formula, CIELAB color coordinate system/color difference formula, CIELUB color coordinate system/color difference formula, yellowness/after-yellowing, whiteness, whiteness B (blue reflectance), Munsell, metamerism, three attributes from CIELUB and their difference, primary wavelength, excitation purity

■ The software is fully equipped with convenient graphic functions including chromaticity diagrams and enlarged color-difference views.

■ It provides a wealth of recalculation functions, enabling items and conditions with respect to the spectra obtained to be changed for recalculation.

■ The visual field (2°, 10°) and the illumination (A, B, C, D65, F6, F8, and F10) are freely selectable. In addition, the user can configure particular weighting coefficients, enabling calculations with respect to any illumination. The configured illumination can also be saved.

■ Standard white plate values can be configured, enabling corrected calculations.

■ Standard samples can be freely specified, enabling color-difference calculations.

■ Thickness conversion calculations are possible with respect to glass, filters, and other transmissive materials.

■ The average and standard deviation of multiple data points can be calculated.

■ Up to 100 data points can be shown.

■ OS: Windows 7 Professional

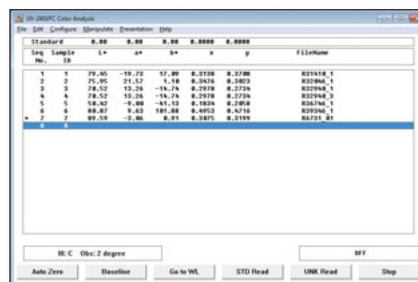

Measurement window

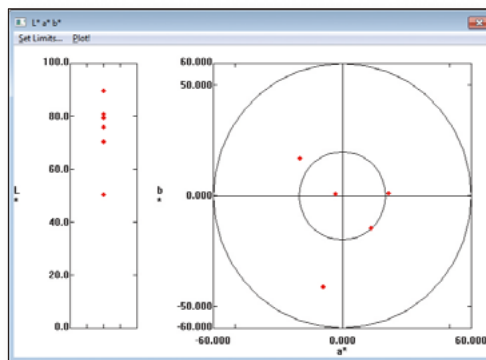

Lab chromaticity diagram display window

# Film Thickness Measurement Software

(P/N 206-66877)

This software measures the thickness of thin films from the wavelengths of peak (or valley) interference waveforms overlapping the spectrum. The film thickness is measured through optical methods without physical contact.

■ The film thickness is calculated from linear regression by applying the method of least squares to the wavelengths of the multiple peaks and valleys automatically detected. (The thin film's refractive index and the angle of incidence must be configured as calculation conditions.)

■ The calculation conditions can be changed with respect to the measured spectra, enabling recalculation.

■ A range can be set for use in the calculations while checking the spectral interference waveform onscreen.

■ The measurable film thickness range is (minimum measured wavelength)/n to 50 × (maximum measured wavelength)/n. (Reference value)

■ OS: Windows 7 Professional

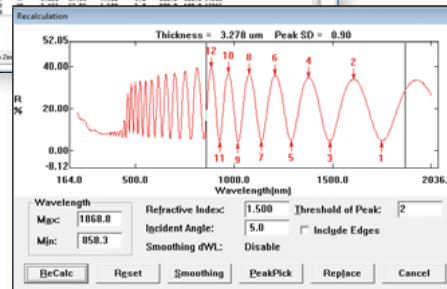
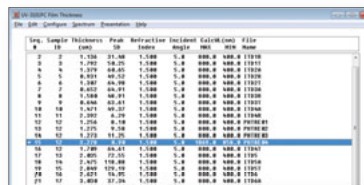

Recalculation window

# Accessories (Options)

## Cells

Description	Optical Path (L)	Required Sample Volume	Type	Fused Silica (S)	Glass (G)
Square cell	10 mm	2.5 mL to 4.0 mL	(1)	200-34442	200-34565
	20 mm	5.0 mL to 8.0 mL	(6)	200-34446	200-34446-01
	50 mm	12.5 mL to 20.0 mL		200-34944	200-34944-01
	100 mm	25.0 mL to 40.0 mL		200-34676	200-34676-01
Square cell with stopper	10 mm	2.5 mL to 4.0 mL	(2)	200-34444	200-34444-01
Semi-micro cell	10 mm	1.0 mL to 1.6 mL	(3) *1	200-66501	200-66501-01
Semi-micro black cell	10 mm	1.0 mL to 1.6 mL	(3)' *1	200-66551	—
Supermicro black cell	5 mm	25 µL to 100 µL	(7)' *2	208-92116	—
	10 mm	50 µL to 200 µL	(7) *2	200-66578-11	—
Micro black cell	10 mm	50 µL to 400 µL	(8) *2	200-66578-12	—
Cylindrical cell	10 mm	3.8 mL	(4)	200-34448 (silica window)	200-34448-01 (glass window)
	20 mm	7.6 mL		200-34472 (silica window)	200-34472-01 (glass window)
	50 mm	19.0 mL		200-34473-01 (silica window)	200-34473-03 (glass window)
	100 mm	38.0 mL		200-34473-02 (silica window)	200-34473-04 (glass window)
Short path cell	1 mm	0.3 mL to 0.4 mL	(5)	200-34660-01	200-34662-01
	2 mm	0.5 mL to 0.8 mL		200-34655	200-34662-11
	5 mm	1.3 mL to 2.0 mL		200-34449	200-34449-01

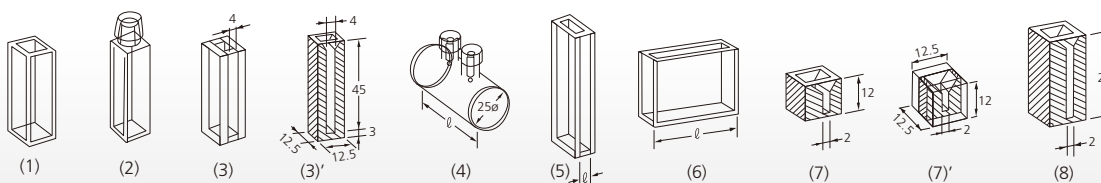

Unit: mm

(Note) \*1 With a 5 nm slit, the cell holder with micro cell mask (P/N 204-06896) is required.  
\*2 The supermicro cell holder (P/N 206-14334) is required.

### Film Holder

(P/N 204-58909)

This holds films, filters, and other thin samples firmly for measurement.

- Sample size  
Minimum: W16 × H32 mm  
Maximum: W80 × H40 × T20 mm



### Rotating Film Holder

(P/N 206-28500-41)

This film holder can rotate samples in a plane centered on the optical axis. Polarizers Type I, II, and III can be attached. The Large Polarizer Set cannot be used.

- Sample size:  
33 mm × 30 mm × 2 mm thick

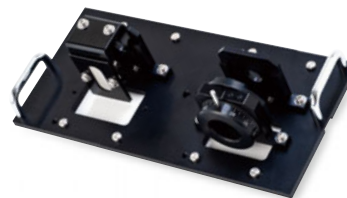

### Four-Cell Sample Compartment Unit

(P/N 206-23670-91)

Accommodates 4-cell holders of various types.

- Incorporates a 4-cell holder for 10-mm square cells.

(Note)  
Square cells are not included as standard.  
Please purchase separately.

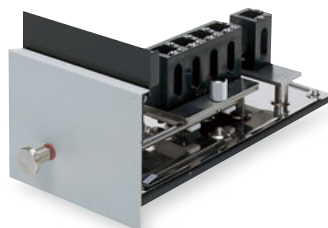

### Multi-Cell Sample Compartment

(P/N 206-69160-01)

Holds up to six 10-mm square cells on the sample side. No temperature control capability.

- Number of cells:  
6 on the sample side  
1 on the reference side

(Note)  
Square cells are not included as standard.  
Please purchase separately.

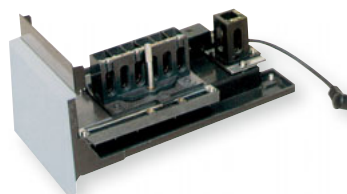

## Universal Rectangular Cell Holder, Four-Cell Type

(P/N 204-27208)

Holds four rectangular cells with an optical path length of 10, 20, 30, 50, 70, or 100 mm.

(Note)

The Four-Cell Sample Compartment Unit (P/N 206-23670-91) is required. When a rectangular, long-path cell is used on the reference side, its holder (P/N 204-28720) is required.

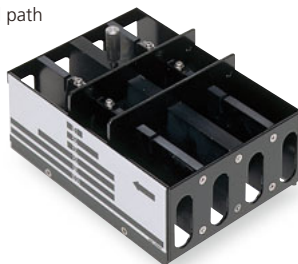

## Reference-Side Rectangular Long-Path Absorption Cell Holder

(P/N 204-28720)

If using a 4-cell-type universal rectangular cell holder, use this as a reference-side cell holder if necessary.



## Long-Path Rectangular Cell Holder

(P/N 204-23118-01)

Holds two rectangular cells with an optical path length of 10, 20, 30, 50, 70, or 100 mm.



## Cylindrical Cell Holder

(P/N 204-06216-02)

Holds two cylindrical cells with an optical path length of 10, 20, 50, or 100 mm.



## Supermicro Cell Holder

(P/N 206-14334)

Holds supermicro cells for measurement of extremely small volume samples. The cell height is adjustable, and the required sample volume can be adjusted in the range of 50 to 200  $\mu\text{L}$ , depending on the type of black cell used.

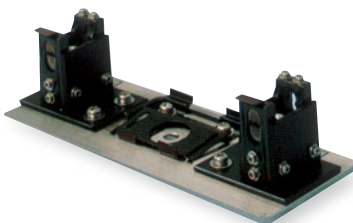

• Applicable cells: (7), (7)', and (8) in the list of cells on page 18. Cells are not included.

• Mask: Choice of W1.5 x H1 mm or W1.5 x H3 mm

## Micro Cell Holder with Mask

(P/N 204-06896)

Required when using semi-micro cells or micro cells with an optical path width of 4 mm or less. (The mask width can be adjusted.)



## 3- $\mu\text{L}$ Capillary Cell Set for Ultramicro Volume Measurement

(P/N 206-69746)

Recommended for small-volume and precious samples, such as in biological applications. The solution sample is aspirated into the capillary cell and the cell is set in the capillary adapter cell, where it is analyzed.

The holder is the same size as a 10-mm square cell and can be mounted to the standard cell holder.

- The minimum sample volume required: 3  $\mu\text{L}$  when the tube closure is used (theoretical value)
- Supplied with 100 capillaries (made of quartz) and a tube closure
- Inner diameter of capillary: 0.5 mm

(Note)

Usually, the effective optical path length is approximately one-twentieth of a 10-mm square cell.





# Accessories (Options)

## 8/16-Series Micro Multi-Cell

### Cell Holders

Model	P/N
8/16-Series Micro Multi-Cell Holder MMC-1600	206-23680-91
8/16-Series Constant-Temperature Micro Multi-Cell Holder MMC-1600C	206-23690-91

This cell holder holds one micro multi-cell, either 8 or 16 cells, for micro-volume measurement. Two types of micro multi-cell holders are available: the standard type (MMC-1600) and the constant-temperature water circulation type (MMC-1600C).

### Micro Multi-Cells

Model	P/N
8-Series Micro Multi-Cell; optical path length: 10 mm; cell volume: 100 $\mu\text{L}$	208-92089
16-Series Micro Multi-Cell; optical path length: 10mm; cell volume: 100 $\mu\text{L}$	208-92088
8-Series Micro Multi-Cell; optical path length: 5 mm; cell volume: 50 $\mu\text{L}$	208-92086
16-Series Micro Multi-Cell; optical path length: 5mm; cell volume: 50 $\mu\text{L}$	208-92085

There are two types of micro multi-cells available for both the 8-series and 16-series models: a 50  $\mu\text{L}$  type and a 100  $\mu\text{L}$  type. The cell intervals of the 8-series micro multi-cells are applicable for use with 8  $\times$  12-well microplates and 8-channel pipettes. Microplate samples aspirated into multi-channel pipettes can be injected directly into the cells for measurement.

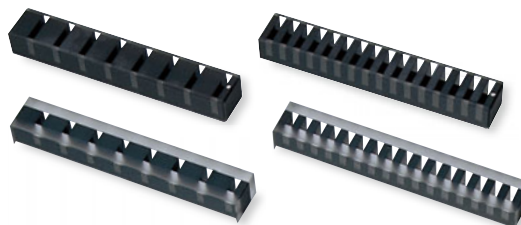
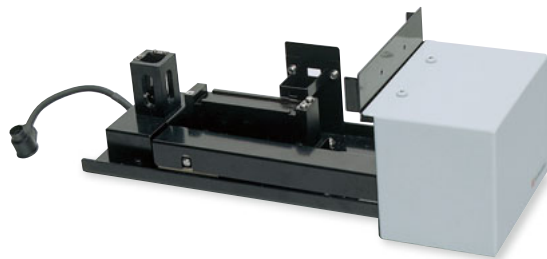

- Micro-volume samples can be measured. (Minimum sample volume: 50  $\mu\text{L}$  to 100  $\mu\text{L}$ )
- Support for commercial microplates and micro pipettes (with 8-series micro cell).
- Up to 16 samples can be measured at a time (with 16-series micro cell).

## CPS-100 Cell Positioner, Thermoelectrically Temperature Controlled (P/N 206-29500-\*\*)

This attachment permits measurement of up to six sample cells under constant-temperature conditions. Combination of this attachment and the Kinetics mode provides measurement of temperature-sensitive enzyme kinetics of one to six samples.

- Number of cells:
  - 6 on the sample side (temperature-controlled)
  - 1 on the reference side (temperature not controlled)
- Temperature control range: 16  $^{\circ}\text{C}$  to 60  $^{\circ}\text{C}$
- Temperature display accuracy:  $\pm 0.5$   $^{\circ}\text{C}$
- Temperature control precision:  $\pm 0.1$   $^{\circ}\text{C}$
- Ambient temperature: 15  $^{\circ}\text{C}$  to 35  $^{\circ}\text{C}$

(Note)

Square cells (P/N 200-34442) are not included as standard. Please purchase separately. A USB adapter CPS (P/N 206-25234-91) is required.



## TCC-100 Thermoelectrically Temperature-Controlled Cell Holder (P/N 206-29510-\*\*)

Uses Peltier effect for controlling the temperatures of the sample and reference sample. No thermostatic bath or cooling water is required, so the operation is quite simple and easy.

- Number of cells: One each on the sample and reference sides (temperature-controlled)
- Temperature control range: 7  $^{\circ}\text{C}$  to 60  $^{\circ}\text{C}$
- Temperature display accuracy:  $\pm 0.5$   $^{\circ}\text{C}$
- Temperature control precision:  $\pm 0.1$   $^{\circ}\text{C}$

(Note)

Square cells (P/N 200-34442) are not included as standard. Please purchase separately.





### Constant-Temperature Cell Holder (P/N 202-30858-04)

Maintains a sample cell and reference cell at a desired, uniform temperature, by circulating constant-temperature water.

- Temperature range: 5 °C to 90 °C  
(depends on the performance of the constant-temperature water circulator)
- Cell holder: Accepts a pair of 10-mm square cells
- Connecting joint outer diameter: 6 mm and 9 mm (two levels)

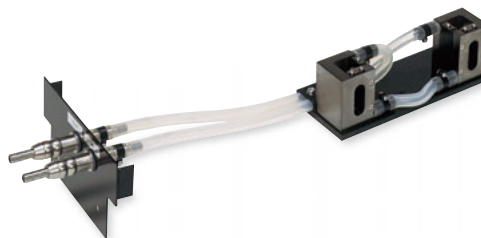

### Constant-Temperature Four-Cell Holder (P/N 204-27206-02)

Maintains four sample cells and a reference cell at a desired, uniform temperature, by circulating constant-temperature water.

- Temperature range: 5 °C to 90 °C  
(depends on the performance of the constant-temperature water circulator)
- Cell holder: Accepts four 10-mm square cells plus a reference cell
- Connecting Joint outer diameter: 9 mm

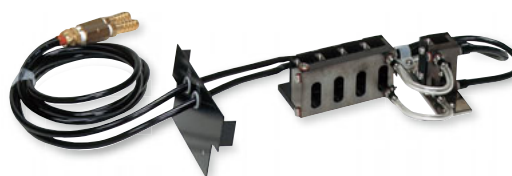

(Note)  
The Four-Cell Sample Compartment Unit (P/N 206-23670-91) is necessary.

### S-1700 Thermoelectric Single-Cell Holder (P/N 206-23900-\*\*)

This cell holder permits setting of a temperature program to increase and decrease the sample cell temperature.

- The thermoelectric system allows prompt control of sample temperature between 0 °C and 110 °C.
- Temperature increase/decrease speed can be changed using 12 settings, which means the holder can be used in analysis of melting curves for nucleic acids, etc. that occur during quick as well as slow heating (or cooling).
- A stirrer is also provided to ensure uniform temperature distribution throughout the cell.
- Cooling water circulation is required for Peltier element cooling. Although tap water can be used, it is recommended that a commercially available constant-temperature water circulator be used, as the following conditions must be fulfilled to extract maximum performance from the S-1700.
  - Cooling water specification: 20 ± 2 °C
  - Water flow: 4.8 L/min or more
- Temperature is not controlled at the reference side.
- Cells are not included. Please use 10-mm square tight-sealing cells (from Hellma).
- Temperature accuracy in cell (when room temperature is 25 °C):  
Within ± 0.25 °C (0 °C to 25 °C)  
Within ± 1 % of set value (25 °C to 75 °C)  
Within ± 2 % of set value (75 °C to 110 °C)



Type	Optical Path Length	Minimum Sample Volume Required
110-QS-10	10 mm	3.5 mL
115B-QS-10	10 mm	400 µL

### TMSPC-8 Tm Analysis System (P/N 206-24350-91)

This system obtains a temperature-versus-absorbance curve data, and the Tm Analysis Software analyzes the Tm (melting temperature) of nucleic acids such as DNA and RNA. The system consists of an 8 Series Micro Multi-Cell Holder, Tm Analysis Software, and Temperature Controller. 8 Series Micro Cells, Silicone Cap, and Constant-Temperature Water Circulator for protecting Peltier device are not included. Please purchase separately.

Description	P/N
8 Series Micro Cell Optical Path 10 mm, Sample Volume 100 µL	208-92097-11
8 Series Micro Cell Optical Path 1 mm, Sample Volume 35 µL	208-92140
Silicone Cap for Micro Cell (24 pcs)	206-57299-91

- Temperature control range: 0.0 to 10.0°C
- Tm Calculation mode: Average Method, Differential Method
- OS: Windows 7 Professional



(Note)  
Please purchase the constant-water circulator which fulfills specifications below.  
Temperature range: 20 ± 2°C, Flow rate: 4.8 L/min or more  
Inner diameter of the connecting pipe: ø8, 10, 12 mm

# Accessories (Options)

## NTT-2200P Constant-Temperature Water Circulator

(P/N 208-97263)

Circulates temperature-controlled water to a constant-temperature cell holder.

- Temperature range: Ambient + 15 °C to + 80 °C
- Temperature control precision:  $\pm 0.05$  °C or more
- Circulation pump: maximum flow rate 27/31 L/min; maximum lift 9.5/13 m (50/60 Hz)
- External circulation nozzle: 10.5 mm O.D. (both outlet and inlet)
- Tank capacity: About 10 L (9 L during use)
- Safety features: Detection of abnormal temperature outside the upper and lower limit range, Detection of heater wire malfunction, Protection from heating too little circulating water, Detection of sensor malfunction, Independent over-heat protection, Over-current circuit protector
- Standard accessories: Lid with handles, 4-m rubber hose (inner diameter: 8 mm; outer diameter: 12 mm; 1 pc), hose clamps (4 pcs), instruction manual (Japanese and English)
- Dimensions: W270 × H560 × D400 mm
- Power requirements: 100 VAC, 1250 VA, with 1.7-m power cord and grounded plug



## Sipper Unit

Model	P/N	Standard Sample Volume
Sipper Unit 160L (Standard Type)	206-23790-91	2.0 mL
Sipper Unit 160T (Triple-Pass Type)	206-23790-92	1.5 mL
Sipper Unit 160C (Constant-Temperature Type)	206-23790-93	2.5 mL
Sipper Unit 160U (Supermicro Type)	206-23790-94	0.5 mL

Four types of sipper units with different flow cell types are available. The stepping motor-driven peristaltic pump ensures reliable and smooth aspiration of sample solution. (Direct driving is possible from the UV-2600/2700, so no interface is required.)

(Note)

The use of a Solenoid Valve (fluoropolymer) (P/N 204-06599-01) and the SWA-2 Sample Waste Unit (P/N 206-23820-91) are recommended when strong acids, strong alkalis, or organic solvents are to be measured.

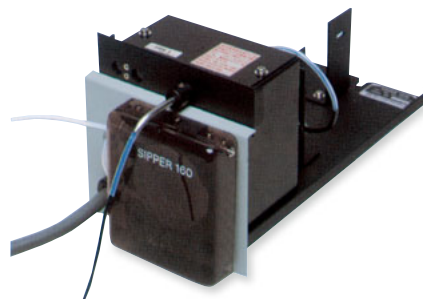

## Syringe Sipper

Model	P/N
Syringe Sipper N (normal temperature type)	206-23890-91
Syringe Sipper CN (constant temperature, water circulator type)	206-23890-92

The sipper unit employs a syringe-pump system. The liquid-contact surfaces are composed of fluoropolymer, glass, and quartz, imparting excellent chemical resistance and ease of maintenance, and allowing measurement of almost any sample type. Furthermore, the extremely high repeatability of sipping volume (repeat precision:  $\pm 0.03$  mL) makes it ideal when performance validation is required.

(Note) Flow cell available separately. Choose from the recommended flow cells listed below.

Recommended Flow Cells				
Cell Type	P/N	Optical Path Length	Dimensions of Aperture	Standard Required Sample Volume
Square (ultra-micro)	208-92114	10 mm	$\phi 2$ mm	0.9 mL
Square (micro)	208-92113	10 mm	$\phi 3$ mm	1.0 mL
Square (semi-micro)	208-92005	10 mm	H11 × W3.5 mm	5.0 mL



- The type of flow cell can be selected in accordance with the application.
- The flow cell can be changed independently for excellent ease of maintenance.
- Circulated-water temperature range: ambient to 60 °C (CN type)

(Note)

If a square flow cell (micro or supermicro) is used, attaching mask R (P/N 206-88679) to the reference cell holder is recommended to balance the light intensity.



## ASC-5 Auto Sample Changer (P/N 206-23810-\*\*) (P/N 206-23810-\*\*)

Combine with a sipper unit or syringe sipper to build an automated multisample spectrophotometry system.

- The aspirating nozzle is programmed to move in the X, Y, and Z (vertical) directions.
- Up to eight sets of operational parameters, including the sizes of racks and the numbers of test tubes, may be stored in the battery backup protected files.
- Up to 100 test tubes may be set together on the rack.

(Note)

A commercially available test tube stand, with a footprint smaller than 220 x 220 mm, is applicable.

An ASC USB adapter (P/N 206-25235-91) is required.



## Sample Pretreatment Automation Connection Kit (P/N 206-80880-02) (P/N 206-80880-02)

The kit enables connection with the Gilson GX-271 Liquid Handler. The liquid handler can automatically perform a variety of sample pretreatments including dispensing, dilution, and the addition of reagents. This kit enables the liquid handler and spectrophotometer to be interlocked for measurements.

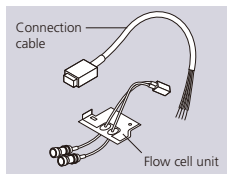

- The connection kit consists of a flow cell unit and connection cable. The liquid handler is not included.



GX-271 Liquid Handler

## Micro Flow Cell (P/N 204-06222) (P/N 204-06222)

Model	P/N	Optical Path Length	Volume
10-mm Micro Flow Cell with Holder	204-06222	10 mL	0.3 mL
5-mm Micro Flow Cell with Holder	204-06222-01	5 mL	0.15 mL

Used for the continuous analysis of samples such as the liquids produced by column chromatography.

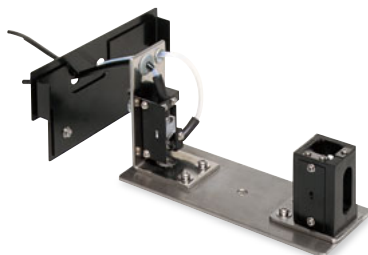

- Inner diameter of tube: 1 or 2 mm

## Front Panel with Holes (P/N 204-27588-03) (P/N 204-27588-03)

Allows the tubes of a flow cell, for example, to be connected through the front panel of the instrument.



## Flow Cell for HPLC (P/N 206-12852) (P/N 206-12852)

With this flow cell attached, the spectrophotometer can be used as a variable-wavelength UV-VIS detector for an HPLC system.

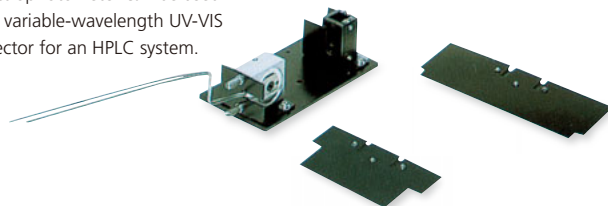

- Inner diameter: 1 mm; Optical path length: 10 mm; Inner volume: 8  $\mu$ L
- Flow cell on the sample side and cell holder with mask on the reference side
- SUS tube: Outer diameter: 1.6 mm; Inner diameter: 0.3 mm

## Low-Pressure Mercury Lamp Unit (P/N 206-28300-41) (P/N 206-28300-41)

This unit is used to install a low-pressure mercury lamp for wavelength accuracy confirmation in the system's light source compartment. It can be interlocked with the validation software provided with the system.



# Accessories (Options)

## ISR-2600 Integrating Sphere Attachment

(P/N 206-28400-41)

## ISR-2600Plus Integrating Sphere Attachment (for UV-2600 only)

(P/N 206-28410-41)

By combining the 0°/8° incidence angle integrating sphere with the S/R exchange function of the spectrophotometer, diffuse and specular reflectance measurements are possible without using any special attachments. The size of the light beam for reflectance measurements can be changed, which enables reflectance measurement of micro samples (minimum light beam dimensions about 2 × 3 mm). Light beams for transmittance measurements can be concentrated to dimensions of 3 × 3 mm. The ISR-2600Plus is an integrating sphere equipped with two detectors: a photomultiplier tube and an InGaAs detector.

### ■ ISR-2600/2600Plus specifications

- Inner diameter of integrating sphere: 60 mm
- Maximum size of reflectance sample: W95 × H135 × T20 mm (0° incidence side)  
W70 × H70 × T12 mm (8° incidence side)

### ■ ISR-2600 specifications

- Measurement wavelength range: 220 to 850 nm
- Noise level: 0.1 %T RMS 500 nm (UV-2600)  
0.3 %T RMS 500 nm (UV-2700)
- 100 % flatness: ± 0.5 %T (UV-2600)  
± 1.5 %T (UV-2700)
- Near-infrared range stray light:  
0.4 %T (1400 nm, H<sub>2</sub>O, 5mm slit, typical value)

### ■ ISR-2600Plus specifications

- Measurement wavelength range: 220 to 1400 nm
- Noise level: 0.1 %T RMS 500 nm  
0.3 %T RMS 900 nm
- 100 % flatness: ± 0.5 %T (220 to 1300 nm)

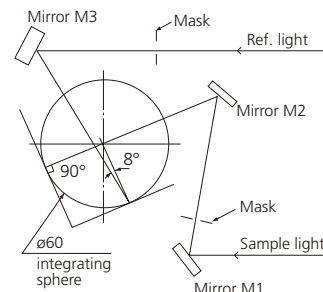

## MPC-2600 Multipurpose Sample Compartment

(P/N 206-28420-41)

The MPC-2600 enables both reflectance and transmittance measurement of samples having a wide variety of shapes. An integrating sphere is built-in to permit accurate measurement of solid samples. The sample space around the integrating sphere is ample enough to allow measurement of very large samples.

- Measurement wavelength range: 240 to 800 nm
- Maximum sample size:  
Transmittance: 305 mm dia. × 50 mm thick or 204 mm dia. × 300 mm thick  
Reflectance: 305 mm dia. × 50 mm thick
- With independent S/R beam switching, 0°/8° incidence angle reflectance measurement is possible without tilting the sample.
- With the integrating sphere shift function, the range of applications is expanded.
- V stage built in. The sample position can be adjusted vertically and laterally.
- Noise level: 0.1 %T RMS 500 nm (UV-2600)  
0.3 %T RMS 500 nm (UV-2700)
- 100 % flatness: 350 to 850 nm  
± 0.5 %T (UV-2600)  
± 1.5 %T (UV-2700)

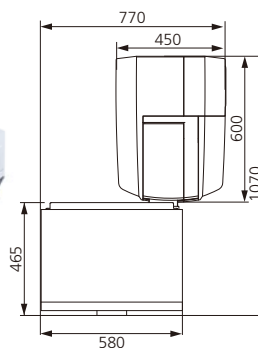

## Specular Reflectance Measurement Attachment (5° Incident Angle)

(P/N 206-14046)

The technique of specular reflectance measurement is often applied to the evaluation of semiconductors, optical materials, multiple layers, etc. relative to a reference reflecting surface. The 5° incident angle minimizes the influence of polarized light. Thus, no polarizer is required for measurement, making the operation quite simple.

- Samples as large as W100 × D160 × T15 mm can be readily measured. The minimum size is 7 mm in diameter.
- Sample placement is easy - just set it on a holder with the measuring surface down.

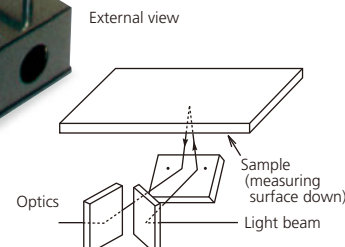

## Absolute Reflectance Attachment

Model	P/N
ASR-3105 Absolute Reflectance Attachment, 5°	206-16817
ASR-3112 Absolute Reflectance Attachment, 12°	206-16100
ASR-3130 Absolute Reflectance Attachment, 30°	206-15001
ASR-3145 Absolute Reflectance Attachment, 45°	206-15002

These accessories are intended for use with the MPC-2600 Sample Compartment, and require the BIS-3100 Sample Base Plate-Integrating Sphere Set (P/N 206-17059). At larger angles of incidence (30°, 45°), a polarizer is also required.

- Measurement wavelength range: 300 to 800 nm
- Accuracy: with respect to 90 % reflectance samples
  - Incidence angle 5°:  $\pm 1.5\%$
  - Incidence angle 12°:  $\pm 1.0\%$
  - Incidence angle 30°, 45°:  $\pm 2.5\%$
- 100 % level sample setting: The sample measurement optical path can be switched using the single-touch V-N method.
- Approximate sample size: 25 to 200 mm dia., or 20 to 150 mm square, up to 30 mm thick

(Note)

The BIS-3100 Sample Base Plate-Integrating Sphere Set (P/N 206-17059) is required for mounting these absolute specular reflectance attachments.

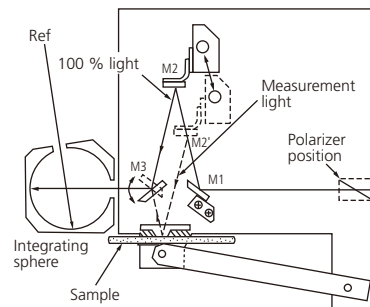

Construction of Absolute Reflectance Attachment

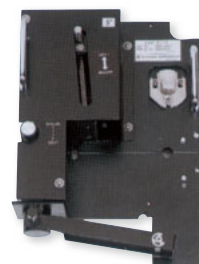

## Large Polarizer Set, Polarizer Type I, II, III

This accessory is for performing measurements when an absolute reflectance attachment is used, with no impact from polarization properties.

The Polarizer Adapter Set (P/N 206-15693) is simultaneously required for Polarizers Type I, II, and III.

Description	P/N	Effective Diameter	Wavelength Range
LRLR-1 Large Polarizer Set	206-15694	20 mm	250 to 2500 nm
PLR-1 Polarizer Type I	206-13236-01	18 mm	400 to 800 nm
PLR-2 Polarizer Type II	206-13236-02	17 mm	260 to 700 nm
PLR-3 Polarizer Type III	206-13163	10 mm	260 to 2500 nm

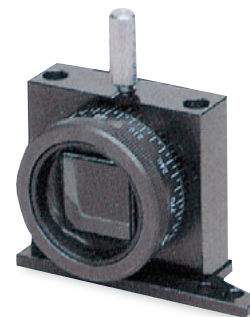

## Powdered Sample Holder

(P/N 206-89065-41)

This powdered sample holder is for attachment to an integrating sphere. It can be attached to all integrating spheres.

- Capacity of 0.16 mL, 3 included



## Analog Output Interface

(P/N 206-25233-91)

Allows analog output for monitoring a liquid chromatograph, etc. and can be connected to an integrator.

- Analog output full scale:  
100 mV / 2 Abs or 100 mV / 100 %T



# Hardware Specifications

Item	UV-2600	UV-2700
Photometric system	Double-beam optics	
Photometric system	Czerny-Turner mounting Single monochromator Lo-Ray-Ligh grade blazed holographic grating	Czerny-Turner mounting Double monochromator Lo-Ray-Ligh grade blazed holographic grating
Detector	R-928 Photomultiplier	
Light source	50 W halogen lamp, deuterium lamp, light source auto position adjustment built in	
Setting wavelength range	185–1400 nm	
Measurement wavelength range	185–900 nm	
	220 nm to 1400 nm when the ISR-2600Plus Integrating Sphere Attachment is used.	The ISR-2600Plus Integrating Sphere Attachment cannot be used.
Wavelength accuracy	± 0.1 nm (656.1 nm D2), ± 0.3 nm (all range)	
Wavelength repeatability	± 0.05 nm	
Wavelength scanning speed	Wavelength slew rate: about 14000 nm/min Wavelength scan rate: about 4000 to 0.5 nm/min	
Wavelength setting	At 1 nm units for scan start and scan end wavelengths, and 0.1 nm units for other wavelengths	
Lamp interchange wavelength	Auto switching synchronized with wavelength; switching range selectable between 290 and 370 nm (0.1 nm units)	
Spectral bandwidth	0.1/0.2/0.5/1/2/5 nm L2/L5 (low stray-light mode)	
Resolution	0.1 nm	
Stray light	Max. 0.005 % (220 nm, NaI) Max. 0.005 % (340, 370 nm, NaNO <sub>2</sub> ) Max. 1 % (198 nm, KCl)	Max. 0.00005 % (220 nm, NaI) Max. 0.00002 % (340, 370 nm, NaNO <sub>2</sub> ) Max. 1 % (198 nm, KCl)
Photometric modes	Absorbance (Abs.), transmittance (%), reflectance (%), energy (E)	
Photometric range	Absorbance: –5 to 5 Abs Transmittance, reflectance: 0 to 100000 %	Absorbance: –8.5 to 8.5 Abs Transmittance, reflectance: 0 to 100000 %
Photometric accuracy	± 0.002 Abs (0.5 Abs) ± 0.003 Abs (1 Abs) ± 0.006 Abs (2 Abs) ± 0.3 %T Measured using NIST930D/NIST1930 or equivalent filter	
Photometric repeatability	± 0.001 Abs (0.5 Abs) ± 0.001 Abs (1 Abs) ± 0.003 Abs (2 Abs) ± 0.1 %T	
Noise level	0.00003 Abs RMS (500 nm)	0.00005 Abs RMS (500 nm)
Baseline flatness	± 0.0003 Abs (200–860 nm), 1 hour after light source is turned ON	± 0.0004 Abs (200–860 nm), 1 hour after light source is turned ON
Baseline stability	Within 0.0002 Abs/h (700 nm), 1 hour after light source is turned ON	Within 0.0003 Abs/h (700 nm), 1 hour after light source is turned ON
Sample compartment	Internal dimensions: W150 × D260 × H140 (mm) Distance between light beams: 100 mm Maximum optical path length of cell: 100 mm	
Dimensions	W450 × D600 × H250 (mm)	
Weight	23 kg	
Operating temperature	15°C to 35°C	
Operating humidity	30 % to 80 % (no condensation, less than 70 % above 30 °C)	
Power requirements	100 to 240 VAC, 50/60 Hz	
Power consumption	170 VA	

(PC and printer not included.)

## Installation Area Plan (UV-2600/2700)

Additional space is required for the PC and printer.

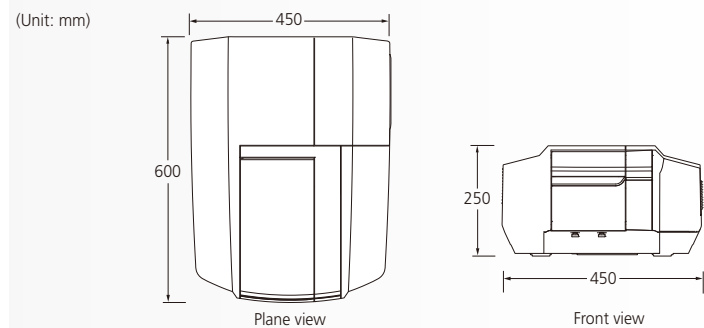

### Standard Contents (Note 1)

Description	Q'ty
Spectrophotometer main unit	1
Standard accessories	
• Power cable	1
• USB cable	1
Software	
• UVProbe software	1
• UV Validation software	
Instruction manual	1
High-Level Absorbance Measurement Kit (UV-2700 only)	1



# Software Specifications

## UVProbe Software

Operating System	Windows 7 Professional (64/32 bits)
Data Acquisition Modes	Spectrum, Photometric (quantitation), and Kinetics (time course)
General	<ul style="list-style-type: none"> <li>• Multitasking (possible to execute data processing while measurement is being performed)</li> <li>• Customizable measurement screen layout (wavelengths, data display font and font size, colors, displayed number of digits)</li> <li>• GLP/GMP compliant (security, history)</li> <li>• Real-time concentration display</li> </ul>
Spectrum Mode	<ul style="list-style-type: none"> <li>• Comparison/interactive processing of multiple spectra <sup>(Note 2)</sup></li> <li>• Storage of all processed data with original data set including a history of all manipulations</li> <li>• Spectrum enlargement/shrinking and auto scale</li> <li>• Automatic interlink with spectral data processing</li> <li>• Annotation on spectrum screen</li> </ul>
Data Processing in Spectrum Mode	<ul style="list-style-type: none"> <li>• Normalization, Point Pick, peak/valley detection, area calculation</li> <li>• 1st – 4th derivatives, smoothing, reciprocal, square root, natural log, Abs, %T conversion, exponential conversion, and Kubelka-Munk conversion</li> <li>• Ensemble averaging, interpolation, four arithmetic operations (between spectra, between spectra and factors)</li> </ul>
Photometric (Quantitation) Mode	<ul style="list-style-type: none"> <li>• Single wavelength, multi-wavelength (includes 1, 2, or 3 wavelengths), spectrum quantitation (peak, maximum, minimum, area, etc. for specified wavelength ranges)</li> <li>• K-factor, single-point, multi-point calibration curves (1st, 2nd, 3rd order function fitting, pass-through-zero specification)</li> <li>• Photometric processing with user-defined functions (+, -, ×, ÷, Log, Exp, etc. functions, including factors)</li> <li>• Weight correction, dilution factor correction, and other corrections using factors</li> <li>• Averaging of repeat measurement data</li> <li>• Simultaneous display of standard sample table, unknown sample table, and calibration curves</li> <li>• Display of Pass/Fail indications</li> </ul>
Kinetics (Time Course) Mode	<ul style="list-style-type: none"> <li>• Comparison/interactive processing of multiple time-course data <sup>(Note 2)</sup></li> <li>• Single- or double-wavelength measurement (difference or ratio)</li> <li>• Simultaneous display of time-course data, enzyme table, and graphs</li> <li>• Enzyme kinetics calculation (for single- or multi-cell)</li> <li>• Michaelis-Menten calculations and graph creation (Michaelis-Menten, Lineweaver-Burk, Hanes, Woolf, Eadie-Hofstee), Dixon plot, Hill plot</li> <li>• Integrated management of sample information including original data, sample weight, and dilution factors, etc.</li> <li>• Event recording such as addition of reagents during measurement</li> <li>• Time-course spectrum data processing (same as in spectrum data processing)</li> </ul>
Report Generator	<ul style="list-style-type: none"> <li>• Preview and print functions for customized formats</li> <li>• Layout and editing of templates</li> <li>• Quick printing using report templates</li> <li>• Auto-printing (spectrum mode)</li> <li>• Multi-page printout</li> <li>• Insertion of date, time, text, and drawing objects including lines, circles and rectangles</li> <li>• Insertion of spectral/quantitative data, method, and history</li> <li>• Insertion of headers and footers</li> <li>• Specification of graph line thickness (for each module), font style, and size</li> </ul>

## UV Validation Software

Inspection Items	<ul style="list-style-type: none"> <li>• Initialization results log</li> <li>• Wavelength accuracy</li> <li>• Wavelength repeatability</li> <li>• Photometric accuracy</li> <li>• Photometric repeatability</li> <li>• Resolution</li> <li>• Stray light</li> <li>• Baseline flatness</li> <li>• Noise level</li> <li>• Drift (baseline stability)</li> </ul>
Features	<ul style="list-style-type: none"> <li>• Select the items to implement during inspection to confirm the approximate time required for full inspection.</li> <li>• The system is capable of both wavelength repeatability checks and wavelength accuracy checks using a wavelength calibration filter. If the optional mercury lamp unit is used, wavelength accuracy can be inspected using the low-pressure mercury lamp's bright line.</li> <li>• The software is capable of resolution inspections using methods defined in the EP (European Pharmacopoeia) and USP (United States Pharmacopoeia) as well as the method for checking the bright line spectral bandwidth.</li> </ul>

### (Note)

- 1) The PC, CRT, and printer are not included as standard.
- 2) Depends on the specifications (including memory capacity) of the PC used.  
As a guideline, 20 to 30 sets of spectral data can be handled simultaneously.

General requirements for UVProbe to operate are indicated below.

- 1 GB min. of empty hard disk space
- XGA or better video adapter and monitor, with a recommended resolution of at least 1024 × 768 pixels
- USB port
- Graphics printer
- Mouse or similar pointing device
- CD-ROM drive

Even with the above configuration, UVProbe operating performance cannot be guaranteed, depending on Windows settings, hardware state, etc.  
Use Shimadzu recommended equipment, if possible.



Shimadzu Corporation  
[www.shimadzu.com/an/](http://www.shimadzu.com/an/)

Company names, product/service names and logos used in this publication are trademarks and trade names of Shimadzu Corporation or its affiliates, whether or not they are used with trademark symbol "TM" or "®".  
Third-party trademarks and trade names may be used in this publication to refer to either the entities or their products/services. Shimadzu disclaims any proprietary interest in trademarks and trade names other than its own.

For Research Use Only. Not for use in diagnostic procedures.  
The contents of this publication are provided to you "as is" without warranty of any kind, and are subject to change without notice. Shimadzu does not assume any responsibility or liability for any damage, whether direct or indirect, relating to the use of this publication.